



PREPARATION

- * Enlever la roue de secours.
- * Baisser le pot d'échappement.
- * Sous le véhicule, à l'intérieur des longérons, repérer et enlever les 4 obturateurs (2+2) correspondants aux points X.

MONTAGE

- * Fixer le bras droit "b" aux points X avec l'ensemble visserie X (fig.1).
- * Fixer le bras gauche "c" aux points X avec l'ensemble visserie X (fig.2).
- * Fixer la traverse "a" avec les bras "b" et "c" aux points Y avec l'ensemble visserie Y (si il y a du jeu, intercaler les cales de jeux "d").
- * Fixer la rotule "e" aux points Z avec l'ensemble visserie Z.

FINITION

- * Serrer l'ensemble de la visserie aux couples indiqués ci-dessous.
- * Refixer le pot d'échappement.
- * Remettre la roue de secours.

BLOC VISSERIE

- X**
- 4 vis HM10x90 (cl.10.9)
 - 3 cales de jeux (d)
 - 4 entretoises diam.10x20L.61 (f)
 - 4 rondelles plates 10/27
 - 4 rondelles CS10
 - 4 écrous HM10 (cl10)
 - 4 rondelles mousses ép.10 (g)

- Y**
- 2 vis HM12x60 (cl8.8)
 - 2 rondelles CS12
 - 2 écrous HM12 (cl8)

- Z**
- 6 vis HM10x40 (cl8.8)
 - 4 rondelles plates 10x27
 - 6 rondelles CS10
 - 4 écrous HM10 (cl8)

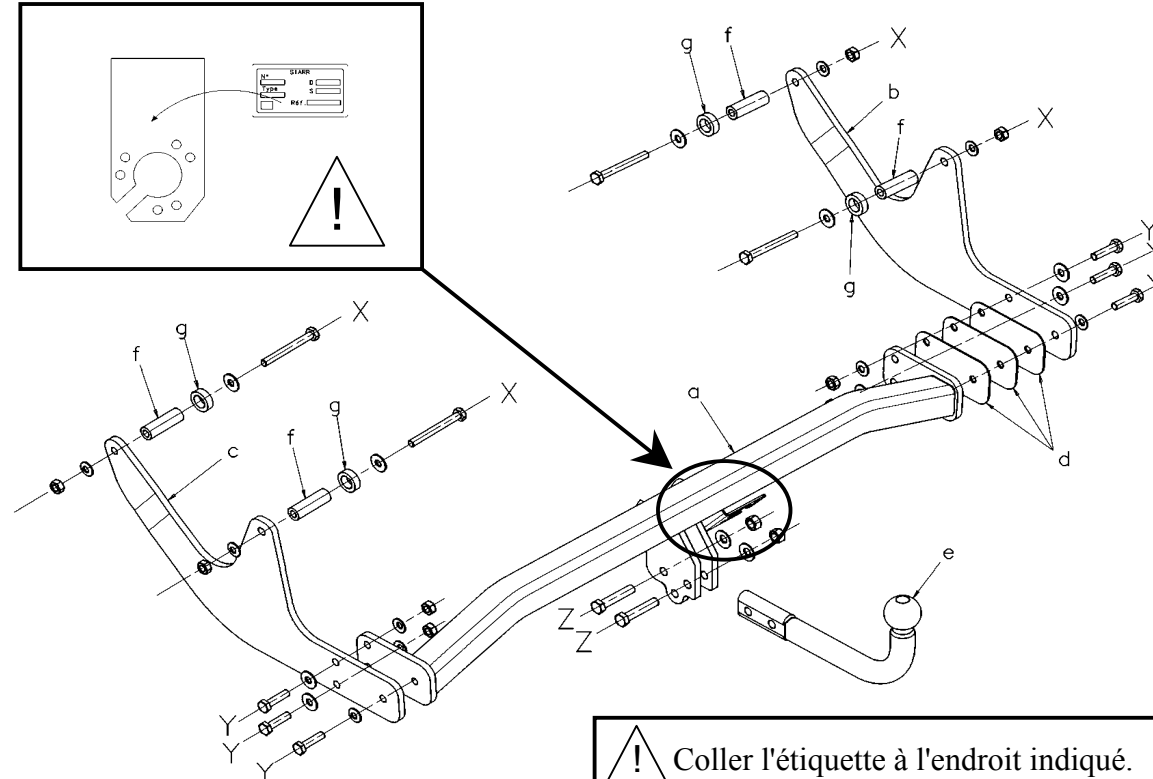
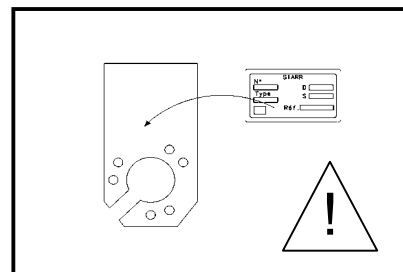
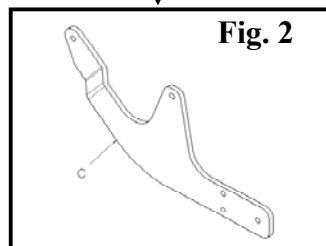
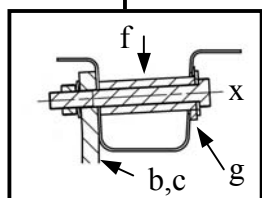
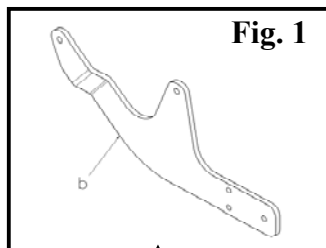

! Coller l'étiquette à l'endroit indiqué.

Type SI024	Homologation de Type n°	Poids Total maxi autorisé	Poids Total remorquable	Charge verticale maxi	Valeur D
Attelage pour Logan Break (RLD)	e24*94/20*00*0049	1 909 kg	1 300 kg	75 kg	7,59 kN

NOTA : Schéma électrique à l'intérieur de nos faisceaux universels ou personnalisés.

COUPLES DE SERRAGE :

M16	AC8.8	19,5daNm	M12	AC10.9	11,4daNm	M8	AC8.8	2,3daNm
M16	AC10.9	27,5daNm	M10	AC8.8	4,7daNm	M8	AC10.9	3,3daNm
M12	AC8.8	8,1daNm	M10	AC10.9	6,7daNm			

ATTENTION : (pour connaître les caractéristiques d'utilisation consulter la carte grise)

Installé suivant nos recommandations, cet attelage vous donnera entière satisfaction. Nous dégageons toute responsabilité en cas de transformation ou d'utilisation illicite de celui-ci.

SIARR

04 - 146



ASSEMBLY INSTRUCTIONS



31625960001

PREPARATION

- * Remove the spare wheel.
- * Drop the exhaust down.
- * Under the vehicle, inside the longitudinals, locate and remove the 4 plugs (2+2) that correspond to the points marked X.

ASSEMBLY

- * Fasten the right arm "b" to the points marked X using fastening kit X (fig.1).
- * Fasten the left arm "c" to the points marked X using fastening kit X (fig.2).
- * Fasten the crosspiece "a" with the arms "b" and "c" to the points marked Y using fastening kit Y (if there is any play, insert the ring shims "d").
- * Fasten the tow ball "e" to the points marked Z using fastening kit Z.

FINISHING

- * Tighten all of the nuts, bolts and screws to the torques indicated below.
- * Refasten the exhaust in place.
- * Replace the spare wheel.

FASTENING KIT

- X**
- 4 off HM10x90 screws (cl.10.9)
 - 3 off ring shims (d)
 - 4 off spacers dia.10x20L.61 (f)
 - 4 off 10/27 plain washers
 - 4 off CS10 washers
 - 4 off HM10 nuts (cl10)
 - 4 off rubber washers, thickness 10 (g)

- Y**
- 2 off HM12x60 screws (cl8.8)
 - 2 off CS12 washers
 - 2 off HM12 nuts (cl8)

- Z**
- 6 off HM10x40 screws (cl8.8)
 - 4 off 10x27 plain washers
 - 6 off CS10 washers
 - 4 off HM10 nuts (cl8)

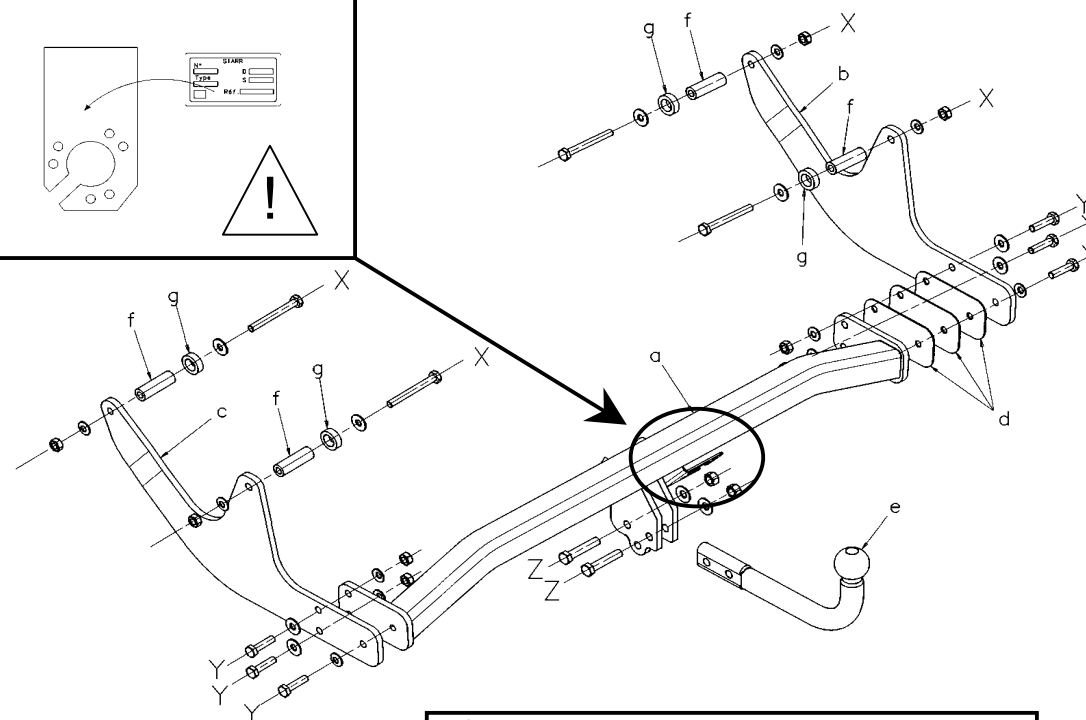
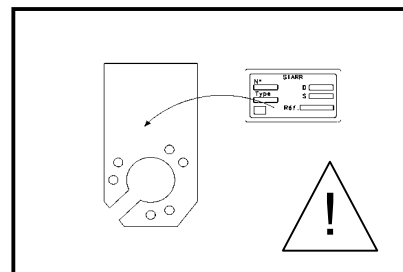
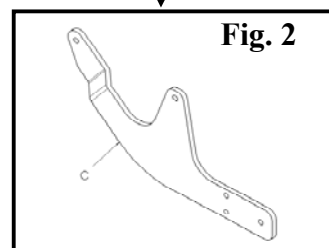
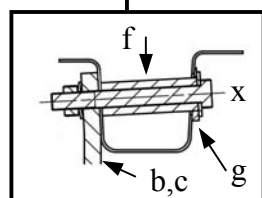
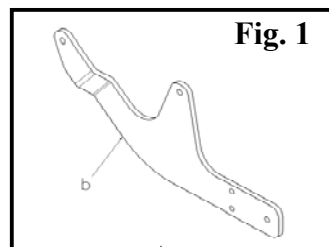

! Affix the sticker in the position

Type SI024	Type Approval No.	Max. Total Authori. Weight	Max. Total Towable Weight	Max. Vertical load	Value D
Tow-bar for Logan Break (RLD)	e24*94/20*00*0049	1 909 kg	1 300 kg	75 kg	7,59 kN

NB : Electrical diagram inside our universal or custom wiring kits.

TORQUES :

M16	AC8.8	19,5daNm	M12	AC10.9	11,4daNm	M8	AC8.8	2,3daNm
M16	AC10.9	27,5daNm	M10	AC8.8	4,7daNm	M8	AC10.9	3,3daNm
M12	AC8.8	8,1daNm	M10	AC10.9	6,7daNm			

PLEASE NOTE : (to familiarise yourself with the operating characteristics refer to the log)

If this tow bar is fitted in accordance with our recommendations it will give a complete satisfaction. We cannot accept any responsibility in the event of changes to or improper use of this item.

**PŘÍPRAVA**

- * Sundejte rezervní kolo.
- * Sklopte výfuk.
- * Pod vozem uvnitř podélníků najděte a odstraňte kryty (2+2) odpovídající bodům X.

MONTÁŽ

- * Pomocí sady šroubu X upevníte pravé rameno „b“ do bodu X (obr. 1).
- * Pomocí sady šroubů X upevníte levé rameno „c“ do bodů X (Obr. 2).
- * Upevněte příčku „a“ s rameny „b“ a „c“ do bodů Y pomocí sady nástrojů Y (pokud zůstává vůle, vložte podložky „d“).
- * Upevněte kulový čep „e“ do bodů Z pomocí sady šroubů Z.

DOKONČOVACÍ PRÁCE

- * Celý komplet utáhněte na níže uvedený utahovací moment
- * Upevněte zpět výfuk.
- * Umístěte zpět rezervní kolo

SADY ŠROUBŮ

- X**
- 4 šrouby HM10x90
 - 3 podložky na vyrovnání vůle (e)
 - 4 rozpěr rozm. 10x20 L:61 (f)
 - 4 ploché podložky 10x27
 - 4 podložky CS10
 - 4 šroubů HM10
 - 4 pěnové podložky tl. 10 (g)

- Y**
- 2 šrouby HM12x60
 - 2 podložky CS12
 - 2 šroubů HM12

- Z**
- 6 šrouby HM10x40
 - 4 ploché podložky 10x27
 - 6 podložky CS10
 - 4 šroubů HM10

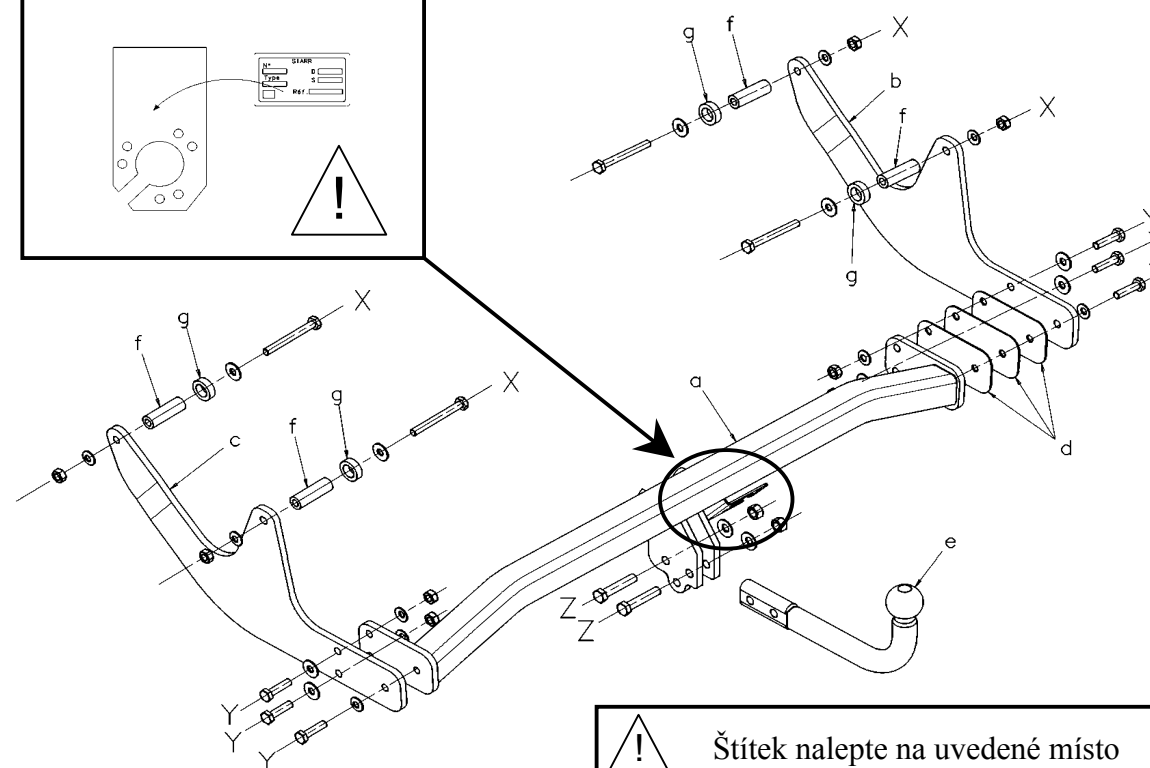
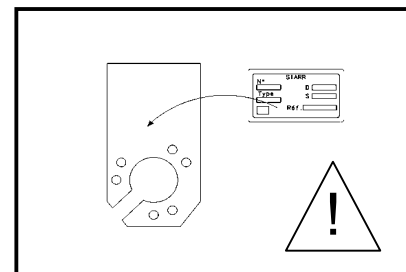
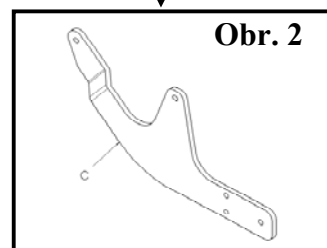
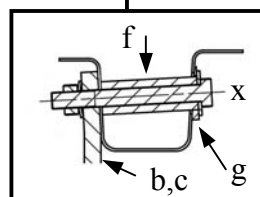
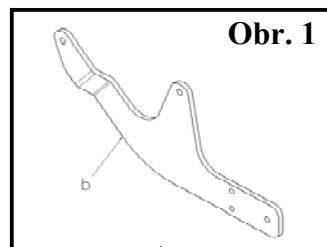

! Štítek nalepte na uvedené místo

Typ SI024	Homologace Typu č.	Celková maximální povolená váha	Celková tažná hmotnost	Maximální ver- tikální zatížení	Hodnota D
Tažné zařízení pro Logan Break (RLD)	e24*94/20*00*0049	1 909 kg	1 300 kg	75 kg	7,59 kN

POZNÁMKA: Elektrické schéma univerzálních nebo na míru upravených svazků.

UPÍNACÍ MOMENTY:

M16	AC8.8	19,5daNm	M12	AC10.9	11,4daNm	M8	AC8.8	2,3daNm
M16	AC10.9	27,5daNm	M10	AC8.8	4,7daNm	M8	AC10.9	3,3daNm
M12	AC8.8	8,1daNm	M10	AC10.9	6,7daNm			

POZOR: (uživatelské charakteristiky naleznete v technickém průkazu)

Tažné zařízení instalované dle našich doporučení vás plně uspokojí.
V případě přestavby nebo neoprávněného užívání se zbavujeme veškeré odpovědnosti



FORBEREDELSE

- * Fjern reservehjulet.
- * Sænk udstødningspotten.
- * På undervognen i vangerne afmærkes og fjernes de 4 propper (2+2), svarende til punkterne X.

MONTERING

- * Fastgør højre bærearmlen « b » ved punkterne X med befæstelserne ved X (fig.1).
- * Fastgør venstre bærearmlen « c » ved punkterne X med befæstelserne ved X (fig.2).
- * Fastgør traversen « a » med bærearmlen « b » og « c » ved punkterne Y med befæstelserne ved Y (hvis der er et spillerum, indsættes afstandsstykkerne « d »).
- * Fastgør kugleledet « e » ved punkterne Z med befæstelserne ved Z.

TIL SLUT

- * Tilspænd alle bolte og møtrikker med nedennævnte momenter.
- * Genmonter udstødningspotten.
- * Ilæg reservehjulet.

BEFÆSTELSER

X	4 bolte HM10x90 (c1.10.9)	Y	2 bolte HM12x60 (c18.8)
	3 afstandsstykker (d)		2 skiver CS12
	4 afstandsstykker med dia.10x20L.61 (f)		2 møtrikker HM12 (c18)
	4 flade skiver 10/27		Z
4 skiver CS10	4 flade skiver 10x27		
4 møtrikker HM10 (c110)	6 skiver CS10		
4 skumskiver, tykkelse 10 (g)	4 møtrikker HM10 (c18)		

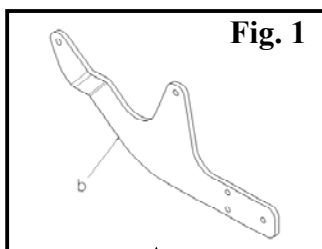

Fig. 1

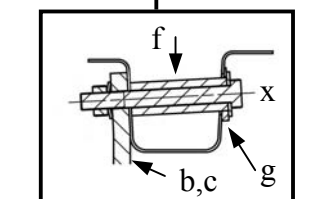
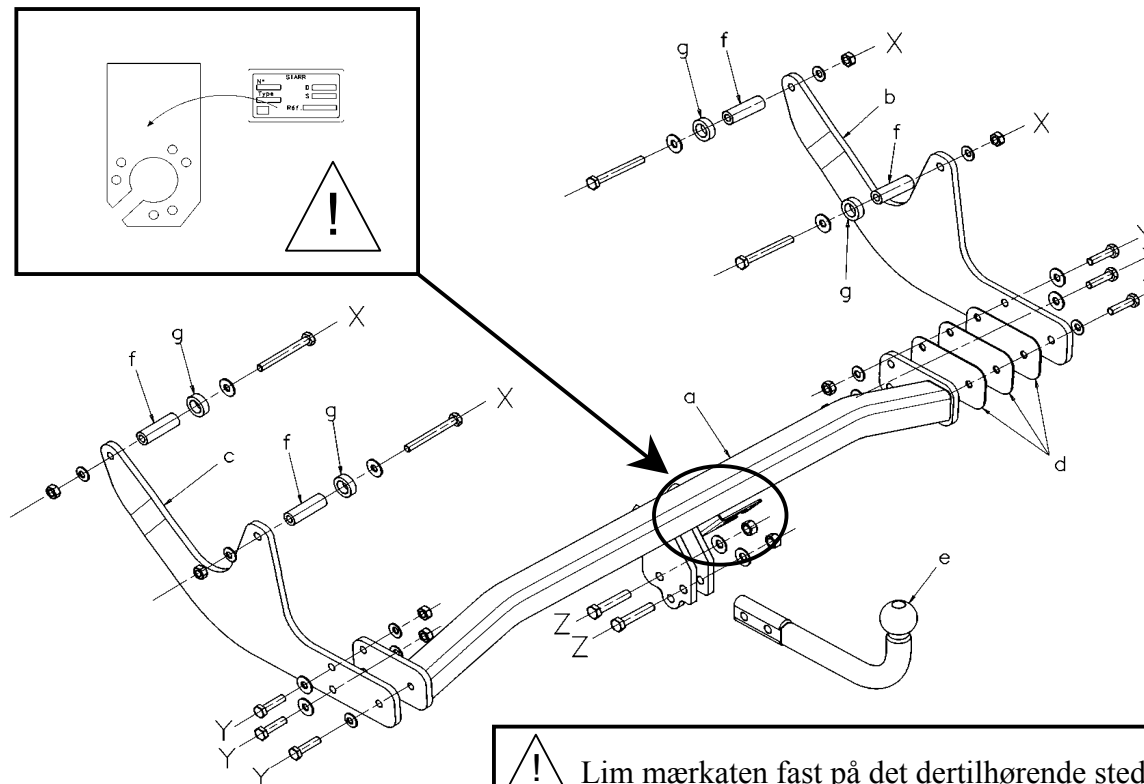

Fig. 2



Type SI024	Godkendt typenr.	Totalvægt maks. tilladt	Totalvægt anhængervægt	Kugletryk maks.	Værdi D
Anhængertræk til Logan Break (RLD)	e24*94/20*00*0049	1 909 kg	1 300 kg	75 kg	7,59 kN

NB: El-skema for vores universelle eller specielle ledningsnet.

TILSPÆNDINGSMOMENT:

M16	AC8.8	19,5daNm	M12	AC10.9	11,4daNm	M8	AC8.8	2,3daNm
M16	AC10.9	27,5daNm	M10	AC8.8	4,7daNm	M8	AC10.9	3,3daNm
M12	AC8.8	8,1daNm	M10	AC10.9	6,7daNm			

BEMÆRK: (for yderligere oplysninger om anvendelsesforhold henvises der til registreringsattesten)

Hvis dette anhængertræk monteres i henhold til vores anvisninger, vil det være til din fulde tilfredshed. Vi fralægger os ethvert ansvar ved ulovlig ændring eller brug af anhængertrækket.



VORBEREITUNG

- * Das Reserverad entfernen.
- * Den Auspufftopf absenken.
- * Unter dem Fahrzeug die 4 (2+2) den Punkten X entsprechenden Blenden in den Längsträgern lokalisieren und entfernen.

MONTAGE

- * Den rechten Arm „b“ mit dem Schraubensatz X an den Punkten X befestigen (Abb.1).
- * Den linken Arm „c“ mit dem Schraubensatz X an den Punkten X befestigen (Abb.2).
- * Die Querstange „a“ mit den Armen „b“ und „c“ mit dem Schraubensatz Y an den Punkten Y befestigen (**ist noch Spiel vorhanden, die Unterlegscheiben „d“ dazwischenschieben**).
- * Die Kupplungskugel „e“ mit dem Schraubensatz Z an den Punkten Z befestigen.

FERTIGSTELLUNG

- * Alle Schrauben mit den nachstehend angegebenen Drehmomenten festziehen.
- * Den Auspufftopf wieder befestigen.
- * Das Reserverad wieder einlegen.

SCHRAUBENSATZ

X	4 Schrauben HM10x90 (cl.10.9)	Y	2 Schrauben HM12x60 (cl.10.9)
	3 Unterlegscheiben (d)		2 Scheiben CS12
	4 Querstreben Durchm.10x20L.61 (f)		2 Schraubenmuttern HM12 (cl8)
	4 flache Scheiben 10/27		
	4 Scheiben CS10	Z	6 Schrauben HM10x40 (cl8.8)
	4 Schraubenmuttern HM10 (cl10)		4 flache Scheiben 10x27
	4 Schaumstoffscheiben der Dicke10 (g)		6 Scheiben CS10
			4 Schraubenmuttern HM10 (cl8)

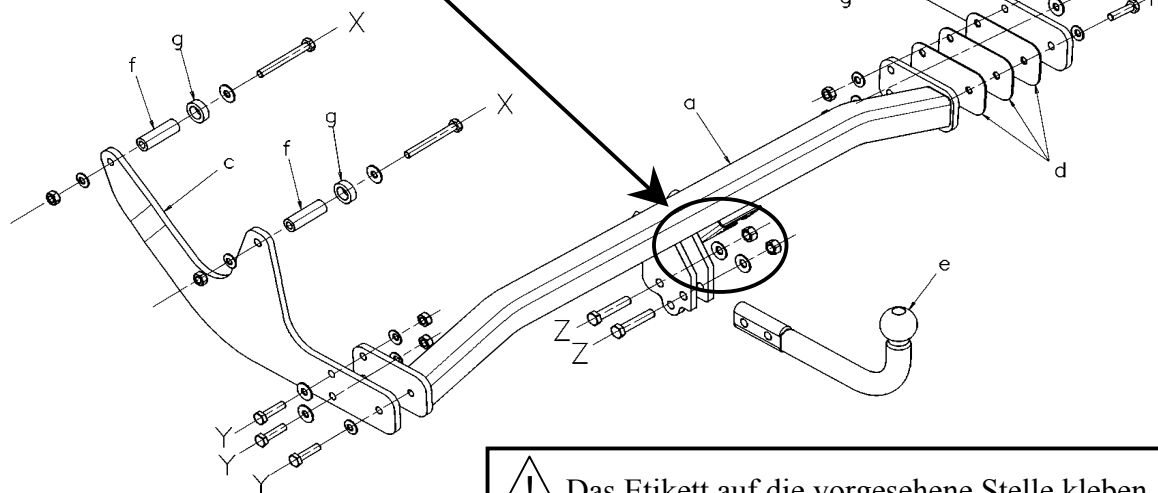
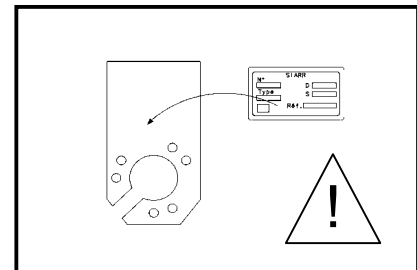
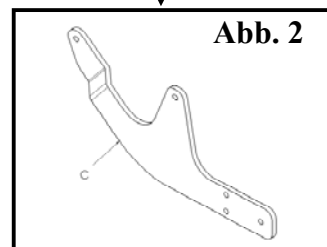
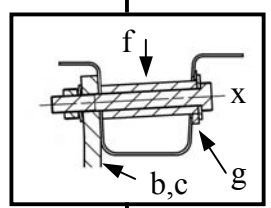
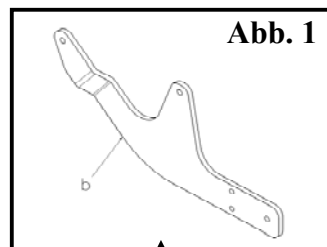

! Das Etikett auf die vorgesehene Stelle kleben.

Typ SI024	Amtliche Zulassung vom Typ Nr.	Maximal zulässiges Gesamtgewicht	Maximal zulässiges Gesamtanhängelast	Vertikale Höchstlast	Wert D
Kupplung für Logan Break (RLD)	e24*94/20*00*0049	1 909 kg	1 300 kg	75 kg	7,59 kN

HINWEIS: Elektroschema liegt unseren allgemein oder individuell einsetzbaren Kabelbäumen bei.

ANZUGSDREHMOMENTE:

M16	AC8.8	19,5daNm	M12	AC10.9	11,4daNm	M8	AC8.8	2,3daNm
M16	AC10.9	27,5daNm	M10	AC8.8	4,7daNm	M8	AC10.9	3,3daNm
M12	AC8.8	8,1daNm	M10	AC10.9	6,7daNm			

ACHTUNG: (Nutzungsmerkmale siehe Fahrzeugschein)

Diese Kupplung wird Sie voll zufrieden stellen, sofern Sie sie unseren Empfehlungen gemäß einbauen.
Im Falle der unerlaubten Veränderung oder des unerlaubten Gebrauchs der Kupplung lehnen wir jede Haftung ab.

SIARR

04 - 146



ΣΗΜΕΙΩΣΗ ΤΟΠΟΘΕΤΗΣΗΣ



316259600001

ΠΡΟΕΤΟΙΜΑΣΙΑ

- * Αφαιρέστε τον εφεδρικό τροχό (ρεζέρβα).
- * Χαμηλώστε το σιλανσιέ .
- * Κάτω από το όχημα , στο εσωτερικό των μηκίδων εντοπίστε και αφαιρέστε τα 4 βύσματα (2+2) που αντιστοιχούν στα σημεία X.

ΤΟΠΟΘΕΤΗΣΗ

- * Στερεώστε τον δεξιά βραχίονα « b » στα σημεία X με όλες τις βίδες X (Σχ. 1).
- * Στερεώστε τον αριστερό βραχίονα « c » στα σημεία X με όλες τις βίδες X (Σχ.2).
- * Στερεώστε την τραβέρσα « a » με τους βραχίονες « b » και « c » στα σημεία Y με όλες τις βίδες Y (εάν υπάρχει τζόγος, παρεμβάλετε τις σφήνες τζόγου « d »).
- * Στερεώστε τον σφαιρικό σύνδεσμο « e » στα σημεία Z με όλες τις βίδες Z.

ΤΕΛΕΙΩΜΑ

- * Σφίξτε όλες τις βίδες με ροπή στρέψης την αναφερόμενη παρακάτω.
- * Στερεώστε το σιλανσιέ.
- * Βάλτε στην θέση της τη ρεζέρβα.

ΣΥΝΟΛΑ ΚΟΧΛΙΩΝ

X

- 4 βίδες HM10x90 (cl.10.9)
- 3 σφήνες τζόγου (d)
- 4 αποστάτες διαμ.10x20L.61 (f)
- 4 ροδέλες πλακέ 10/27
- 4 ροδέλες CS10
- 4 περικόχλια HM10 (cl10)
- 4 ροδέλες αμβλείες παχ.10 (g)

Y

- 2 βίδες HM12x60 (cl8.8)
- 2 ροδέλες CS12
- 2 περικόχλια HM12 (cl8)

Z

- 6 βίδες HM10x40 (cl8.8)
- 4 ροδέλες πλακέ 10x27
- 6 ροδέλες CS10
- 4 περικόχλια HM10 (cl8)

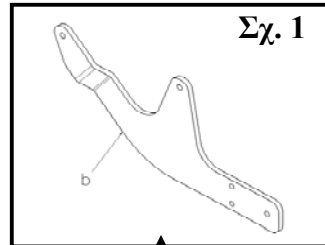

Σχ. 1

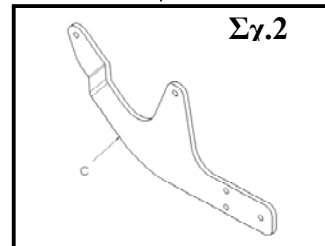
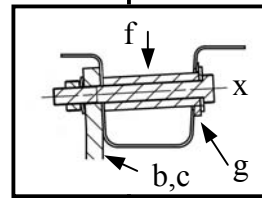

Σχ.2

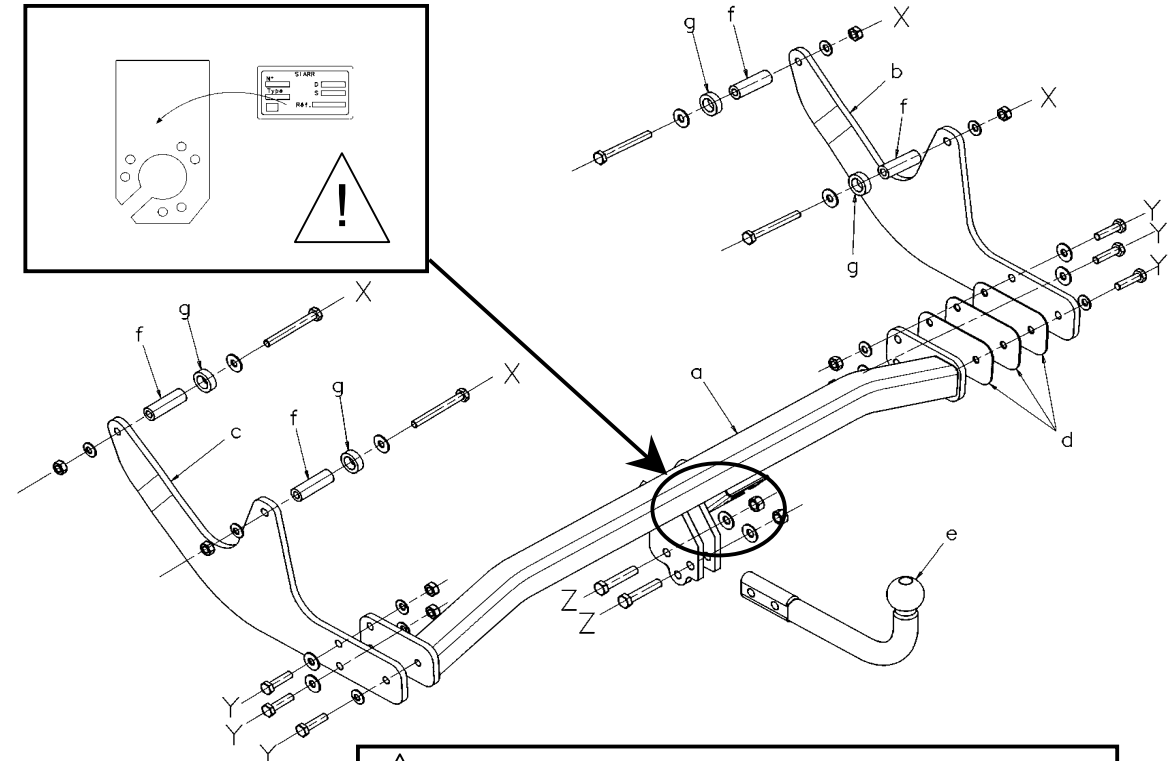
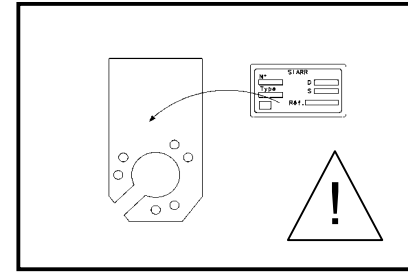

Κολλήστε την ετικέτα στο ενδεικνυόμενο σημείο

Τύπος SI024	Εγκριση Τύπου αριθ.	Ολικό Βάρος μέγ Επιτρεπόμενο	Ολικό Βάρος ρυμουλκίσμο	Κατακόρυφο φορτίομέγ.	Τιμή D
Σύστημα ρυμούλκησης για Logan Break (RLD)	e24*94/20*00*0049	1 909 kg	1 300 kg	75 kg	7,59 kN

ΣΗΜΕΙΩΣΗ : Ηλεκτρικό κύκλωμα στο εσωτερικό των γενικής χρήσεως δεσμών μας ή προσωποποιημένων.

ΡΟΠΕΣ ΣΤΡΕΨΗΣ ΓΙΑ ΤΗΝ ΣΥΣΦΙΞΗ

M16	AC8.8	19,5daNm	M12	AC10.9	11,4daNm	M8	AC8.8	2,3daNm
M16	AC10.9	27,5daNm	M10	AC8.8	4,7daNm	M8	AC10.9	3,3daNm
M12	AC8.8	8,1daNm	M10	AC10.9	6,7daNm			

ΠΡΟΣΟΧΗ : (για να πληροφορηθείτε τα χαρακτηριστικά χρήσης συμβουλευτείτε την γκριζα κάρτα)

Εγκατεστημένο σύμφωνα με τις συστάσεις μας, αυτό το σύστημα ρυμούλκησης θα σας ικανοποιήσει πλήρως.

Απεκδύομεθα π□σης ευθύνης σε περίπτωση μετατροπής ή παράνομης χρήσης αυτού.

SIARR
04 - 146



MANUAL DE MONTAJE



PREPARACIÓN

- * Sacar la rueda de repuesto.
- * Bajar el tubo de escape.
- * Debajo del vehículo, en el interior de los largueros, localizar y retirar los 4 obturadores (2+2) correspondientes a los puntos X.

MONTAJE

- * Fijar el brazo derecho « b » en los puntos X con el conjunto de tornillería X (Fig.1).
- * Fijar el brazo izquierdo « c » en los puntos X con el conjunto de tornillería X (Fig.2).
- * Fijar la travesía « a » con los brazos « b » y « c » en los puntos Y con el conjunto de tornillería Y (si queda juego, intercalar las cuñas de juego « d »).
- * Fijar la rótula « e » en los puntos Z con el conjunto de tornillería Z.

ACABADO

- * Apretar el conjunto de la tornillería con los pares abajo indicados.
- * Volver a colocar el tubo de escape.
- * Volver a colocar la rueda de repuesto.

BLOQUE TORNILLERÍA

X	4 tornillos HM10x90 (cl.10.9)	Y	2 tornillos HM12x60 (cl)
	3 cuñas de juego (d)		2 arandelas CS12
	4 separadores diám.10x20L.61 (f)		2 tuercas HM12 (cl8)
	4 arandelas planas 10/27		Z
4 arandelas CS10	4 arandelas planas 10x27		
4 tuercas HM10 (cl10)	6 arandelas CS10		
4 arandelas de espuma gr.10 (g)	4 tuercas HM10 (cl8)		

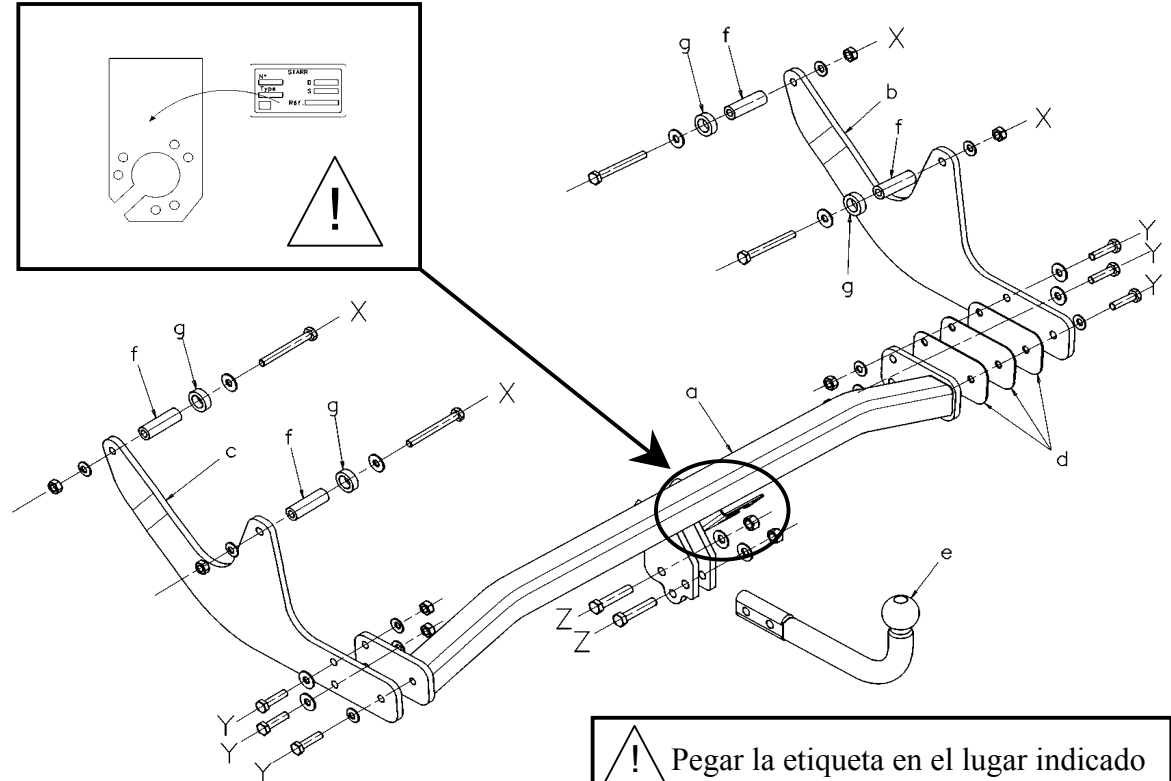
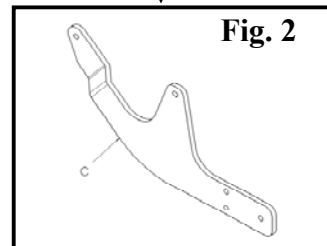
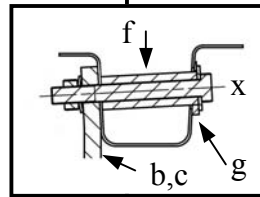
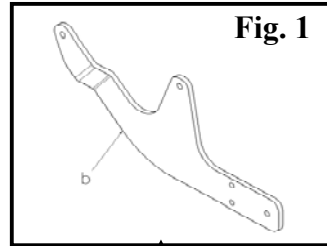

Tipo SI024	Homologación de Tipo nº	Peso Total máximo autorizado	Peso Total remolcable	Carga vertical máxima	Valor D
Enganche para Logan Break (RLD)	e24*94/20*00*0049	1 909 kg	1 300 kg	75 kg	7,59 kN

NOTA: Esquema eléctrico en el interior de nuestros haces universales o personalizados.

PARES DE APRIETE:

M16	AC8.8	19,5daNm	M12	AC10.9	11,4daNm	M8	AC8.8	2,3daNm
M16	AC10.9	27,5daNm	M10	AC8.8	4,7daNm	M8	AC10.9	3,3daNm
M12	AC8.8	8,1daNm	M10	AC10.9	6,7daNm			

ATENCIÓN: (para conocer las características de utilización, consultar el permiso de circulación)

Instalado siguiendo nuestras recomendaciones, este enganche le dará total satisfacción. No asumiremos ninguna responsabilidad en caso de que haya sido transformado o utilizado ilícitamente



VALMISTELU

- * Ota vararengas pois.
- * Laske pakoputkea alas.
- * Etsi ja ota pois ajoneuvon alla pitkittäis-palkkien sisässä 4 tulppaa (2+2), jotka vastaavat pisteitä X.

ASENNUS

- * Kiinnitä oikea varsi « b » pisteisiin X kiinnityskokonaisuuden X avulla (kuva.1).
- * Kiinnitä vasen varsi « c » pisteisiin X kiinnityskokonaisuuden X avulla (kuva.2).
- * Kiinnitä ristikappale « a » varsien « b » ja « c » avulla pisteisiin Y kiinnityskokonaisuuden Y avulla (jos välystä jää, laita väliin välilevyt « d »).
- * Kiinnitä vetonuppi « e » pisteisiin Z kiinnityskokonaisuuden Z avulla.

VIIMEISTELY

- * Kiristä ruuvit, mutterit ja pultit ilmoitetuilla momenteilla.
- * Kiinnitä pakoputki takaisin.
- * Laita vararengas takaisin.

KIINNITYSKOKONAISUUS

X	4 ruuvia HM10x90 (cl.10.9)	Y	2 ruuvia HM12x60 (cl8.
	3 välilevyä (d)		2 välilevyä CS12
	4 välikappaleita halk.10x20L.61 (f)		2 mutteria HM12 (cl8)
	4 litteää välilevyä 10/27		
4 välilevyä CS10	Z	6 ruuvia HM10x40 (cl8.8)	
4 mutteria HM10 (cl10)		4 litteää välilevyä 10x27	
4 vaahtovälilevyä paksuus 10 (g)		6 välilevyä CS10	
		4 mutteria HM10 (cl8)	

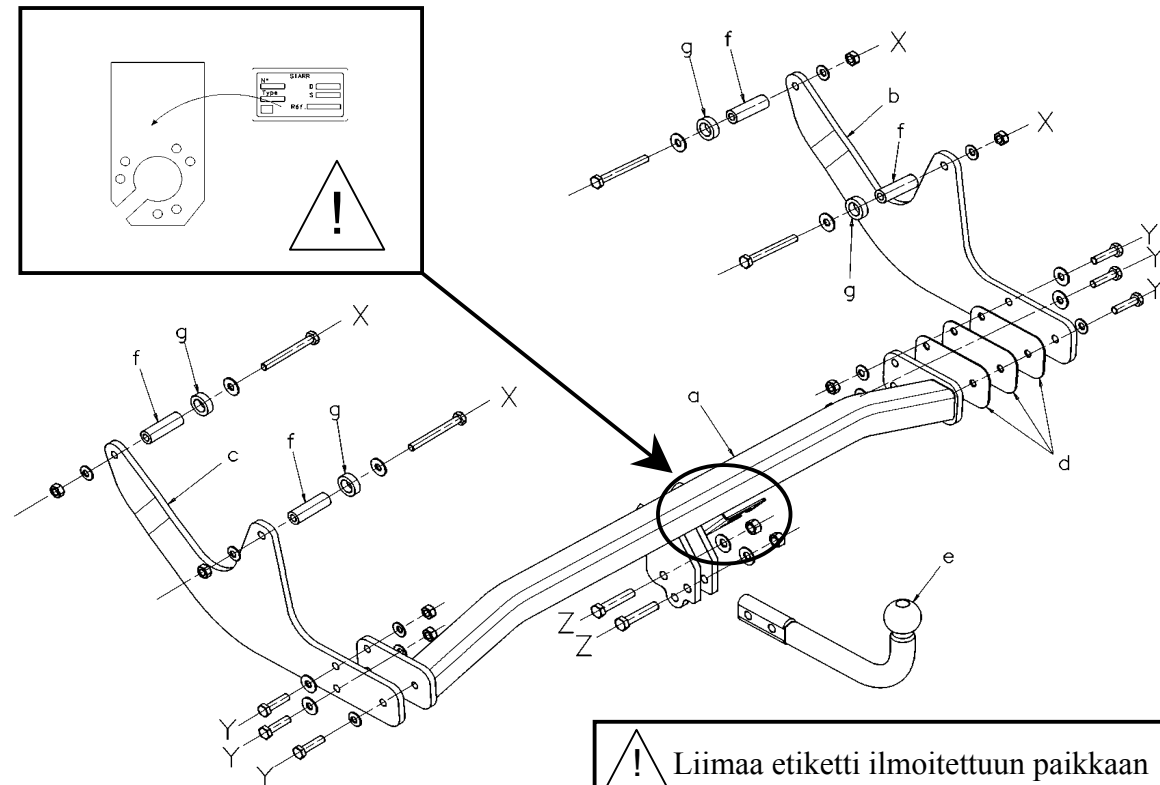
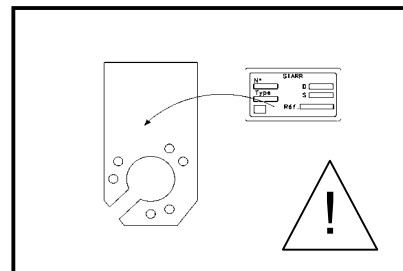
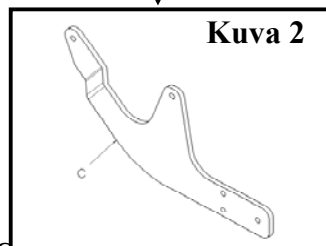
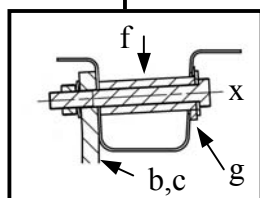
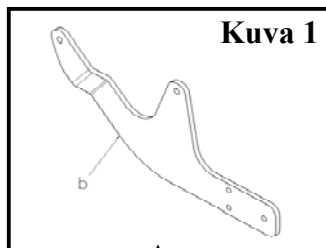

! Liimaa etiketti ilmoitettuun paikkaan

Tyyppi SI024	Tyyppihyväksyntä Numero	Suuri sallittu kokonaiskuorma	Vedettävissä oleva kokonaispaino	Suurin sallittu pystysuora rasitus	Arvo D
Vetokoukku Logan Break (RLD)	e24*94/20*00*0049	1 909 kg	1 300 kg	75 kg	7,59 kN

HUOM: Sähköpiirros on yleisjohtojen tai yksilöllisten johtojen mukana.

KIRISTYSMOMENTIT:

M16	AC8.8	19,5daNm	M12	AC10.9	11,4daNm	M8	AC8.8	2,3daNm
M16	AC10.9	27,5daNm	M10	AC8.8	4,7daNm	M8	AC10.9	3,3daNm
M12	AC8.8	8,1daNm	M10	AC10.9	6,7daNm			

HUOMIO: (käyttöominaisuuksiin tutustumiseksi on katsottava rekisteriotetta)

Suosittelun mukaan asennettuna tämä vetokoukku täyttää odotuksesi.
Emme ota vastuuta, jos laitetta muutetaan tai käytetään ohjeiden vastaisesti.



PREPARAZIONE

- * Togliere la ruota di soccorso.
- * Abbassare la marmitta di scarico.
- * Sotto il veicolo, all'interno dei longheroni, individuare e togliere i 4 otturatori (2+2) corrispondenti ai punti X.

MONTAGGIO

- * Fissare il braccio destro « b » nei punti X con il gruppo viteria X (fig.1).
- * Fissare il braccio sinistro « c » nei punti X con il gruppo viteria X (fig.2).
- * Fissare la traversa "a" alle braccia "b" "e" "c" nei punti Y con il gruppo viteria Y (se c'è gioco, intercalare gli spessori di serie « d »).
- * Fissare il giunto « e » nei punti Z con il gruppo viteria Z.

RIFINITURA

- * Stringere il gruppo della viteria alle coppie qui di seguito indicate.
- * Fissare nuovamente la marmitta di scarico.
- * Rimettere la ruota di soccorso.

BLOCCO VITERIA

- X**
- 4 viti HM10x90 (cl.10.9)
 - 3 spessori di serie (d)
 - 4 distanziatori diam.10x20L.61 (f)
 - 4 rondelle piatte 10/27
 - 4 rondelle CS10
 - 4 dadi HM10 (cl10)
 - 4 rondelle smussate sp.10 (g)

- Y**
- 2 viti HM12x60 (cl8.8)
 - 2 rondelle CS12
 - 2 dadi HM12 (cl8)

- Z**
- 6 viti HM10x40 (cl8.8)
 - 4 rondelle piatte 10x27
 - 6 rondelle CS10
 - 4 dadi HM10 (cl8)

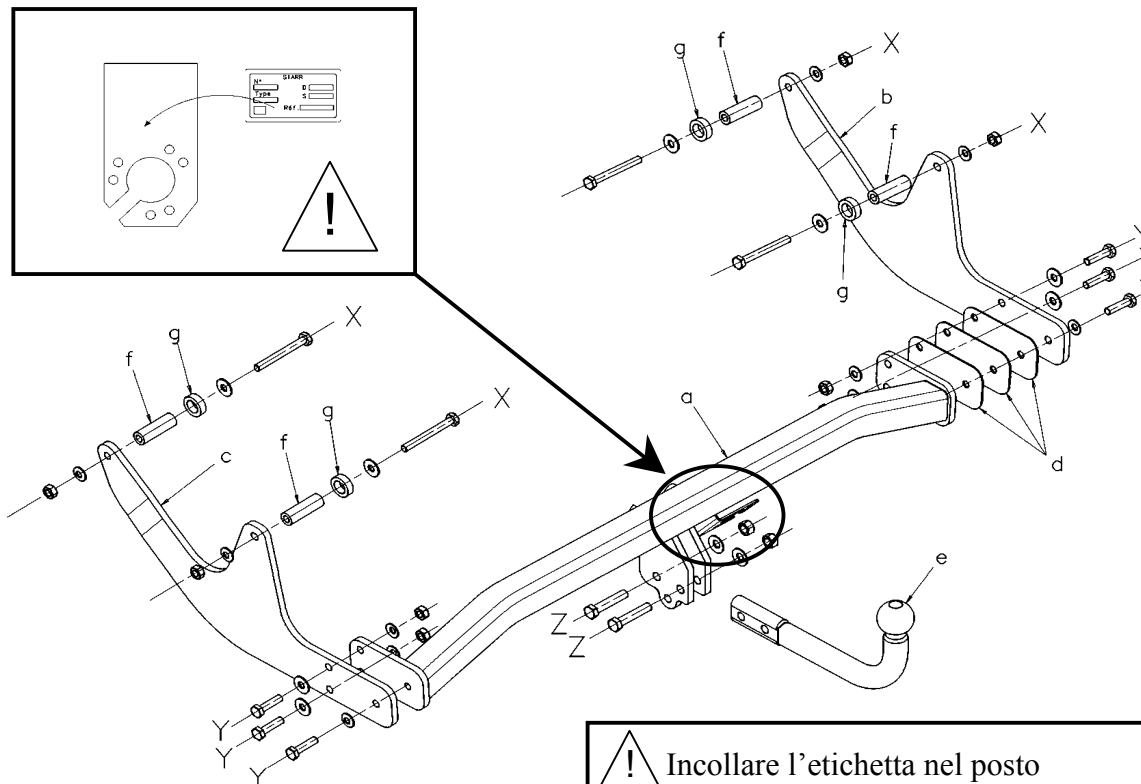
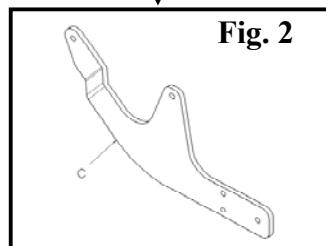
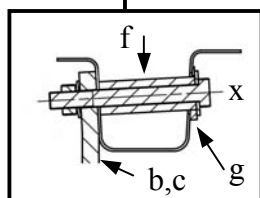
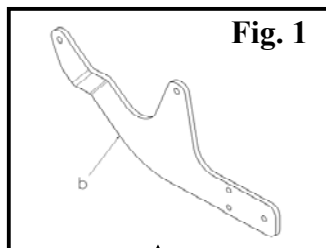

! Incollare l'etichetta nel posto

Tipo SI024	Omologazione di Tipo n°	Peso totale massimo autorizzato	Peso totale Rimorchiabile	Carico verticale massimo	Valore D
Gancio da traino per Logan Break (RLD)	e24*94/20*00*0049	1 909 kg	1 300 kg	75 kg	7,59 kN

NOTA : Schema elettrico all'interno dei nostri fasci universali o personalizzati.

COPPIE DI SERRAGGIO :

M16	AC8.8	19,5daNm	M12	AC10.9	11,4daNm	M8	AC8.8	2,3daNm
M16	AC10.9	27,5daNm	M10	AC8.8	4,7daNm	M8	AC10.9	3,3daNm
M12	AC8.8	8,1daNm	M10	AC10.9	6,7daNm			

ATTENZIONE : (per conoscere le caratteristiche d'uso consultare il libretto di circolazione)

Installato seguendo le nostre raccomandazioni, questo gancio da traino vi lascerà completamente soddisfatti.
Respingiamo ogni responsabilità in caso di trasformazione o utilizzo illecito dello stesso.

SIARR
04 - 146



MONTAGEHANDLEIDING

WESTFALIA
Automotive
31625960001

VOORBEREIDING

- * Haal het reservewiel weg.
- * Laat de uitlaat zakken.
- * Haal de 4 afsluiters (2+2) die overeenkomen met de punten X, aan de binnenkant van de langsliggers onder het voertuig, weg.

MONTAGE

- * Bevestig de rechterarm "b" op de punten X met behulp van alle schroeven X (fig.1).
- * Bevestig de linkerarm "c" op de punten X met behulp van alle schroeven X (fig.2).
- * Bevestig de dwarsligger "a" met de armen "b" en "c" op de punten Y met behulp van alle schroeven Y (bij speling de afstandsplaatjes "d" gebruiken).
- * Bevestig de kogel "e" op de punten Z met behulp van alle schroeven Z.

AFWERKING

- * Draai alle schroeven vast volgens onderstaande aandraaimomenten.
- * Zet de uitlaat weer vast.
- * Zet het reservewiel weer terug.

SCHROEFBLOK

X	4 schroeven HM10x90	Y	2 schroeven HM12x60
	3 afstandsplaatjes (d)		2 ringen CS12
	4 afstandsstukken diam.10x20L.61 (f)		2 moeren HM12
	4 drukplaten 10/27		
4 ringen CS10	Z	6 schroeven HM10x40	
4 moeren HM10		4 drukplaten 10x27	
4 schuimringen dikte 10 (g)		6 ringen CS10	
		4 moeren HM10	

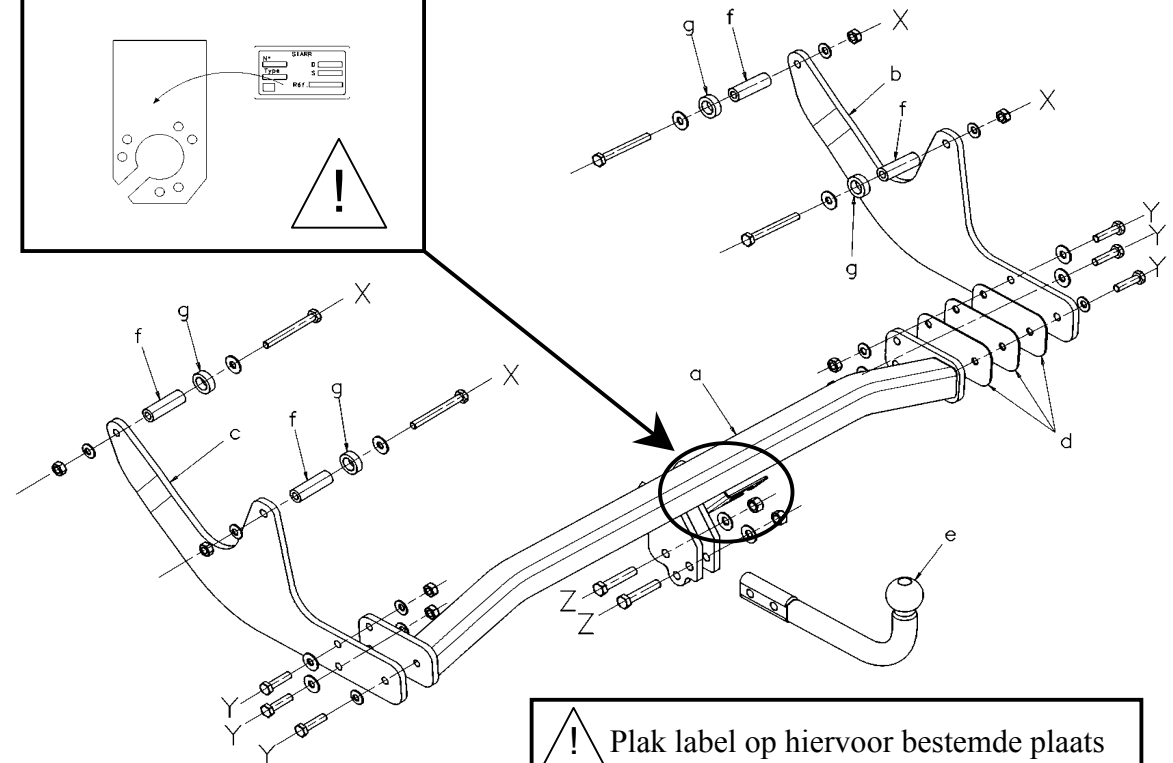
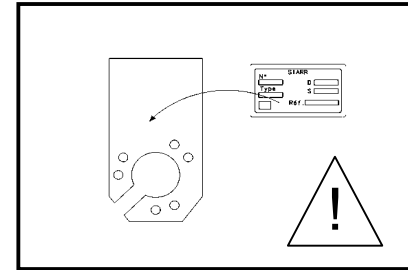
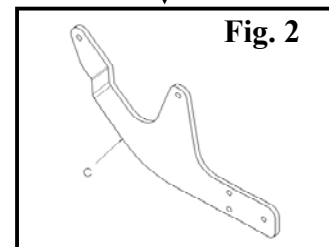
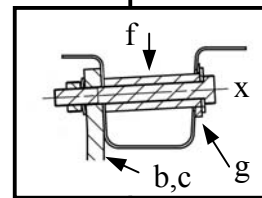
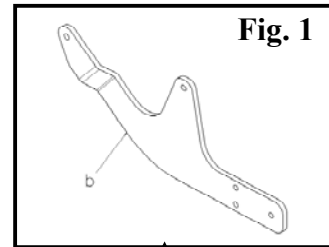

! Plak label op hiervoor bestemde plaats

Type SI024	Goedkeuring Type n°	Max. toegestaan totaalgewicht	Totaal laadgewicht	Max. verticale belasting	Waarde D
Koppeling voor Logan Break (RLD)	e24*94/20*00*0049	1 909 kg	1 300 kg	75 kg	7,59 kN

NOTA BENE: Bedradingschema aan binnenkant van onze universele bundels of gepersonaliseerd.

AANDRAAIMOMENTEN:

M16	AC8.8	19,5daNm	M12	AC10.9	11,4daNm	M8	AC8.8	2,3daNm
M16	AC10.9	27,5daNm	M10	AC8.8	4,7daNm	M8	AC10.9	3,3daNm
M12	AC8.8	8,1daNm	M10	AC10.9	6,7daNm			

LET OP: (voor gebruikskennmerken het kentekenbewijs raadplegen)

Indien u de koppeling volgens onze aanbevelingen heeft geïnstalleerd, zal het u tot volle tevredenheid stemmen. Wij stellen ons niet aansprakelijk in geval van wijziging of onrechtmatig gebruik.

SIARR

04 - 146



MONTERINGSVEILEDNING

WESTFALIA
Automotive
31625960001

FORBEREDELSE

- * Fjern reservehjulet.
- * Senk eksospotten.
- * Se under bilen, på innsiden av lengdebjelkene, og finn og fjern de 4 ventilene (2+2) som hører til punktene X.

MONTERING

- * Fest høyre bærearml «b» til punktene X med skruesettet X (fig.1).
- * Fest venstre bærearml «c» til punktene X med skruesettet X (fig.2).
- * Fest tverrstangen «a» med bærearmlene «b» og «c» til punktene Y med skruesettet Y (hvis det er avstand, juster settet med avstandsstykker «d»).
- * Fest kuleleddet «e» til punktene Z med skruesettet Z.

ENDELIG UTFØRING

- * Stram til skruene i henhold til dreiningsmomentene angitt under.
- * Fest eksospotten igjen.
- * Sett på reservehjulet.

SKRUESETT

X	4 skruer av type HM10x90 (kl.10.9)	Y	2 skruer av type HM12x60 (cl8.8)
	3 sett med avstandsstykker (d)		2 skiver av type CS12
	4 tverrstenger med diameter 10x20 L.61 (f)		2 muttere av type HM12 (kl 8)
	4 tetningsskiver 10/27		6 skruer HM10x40 (kl 8.8)
Z	4 skiver CS10	Z	4 tetningsskiver 10x27
	4 muttere av type HM10 (kl 10)		6 skiver CS10
	4 skumskiver med tykkelse 10 (g)		4 muttere HM10 (kl 8)

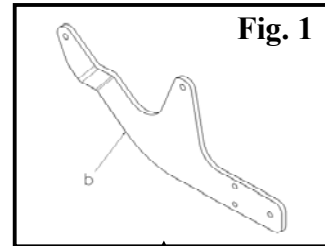

Fig. 1

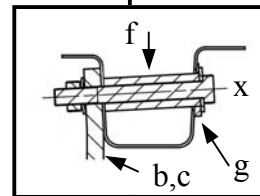
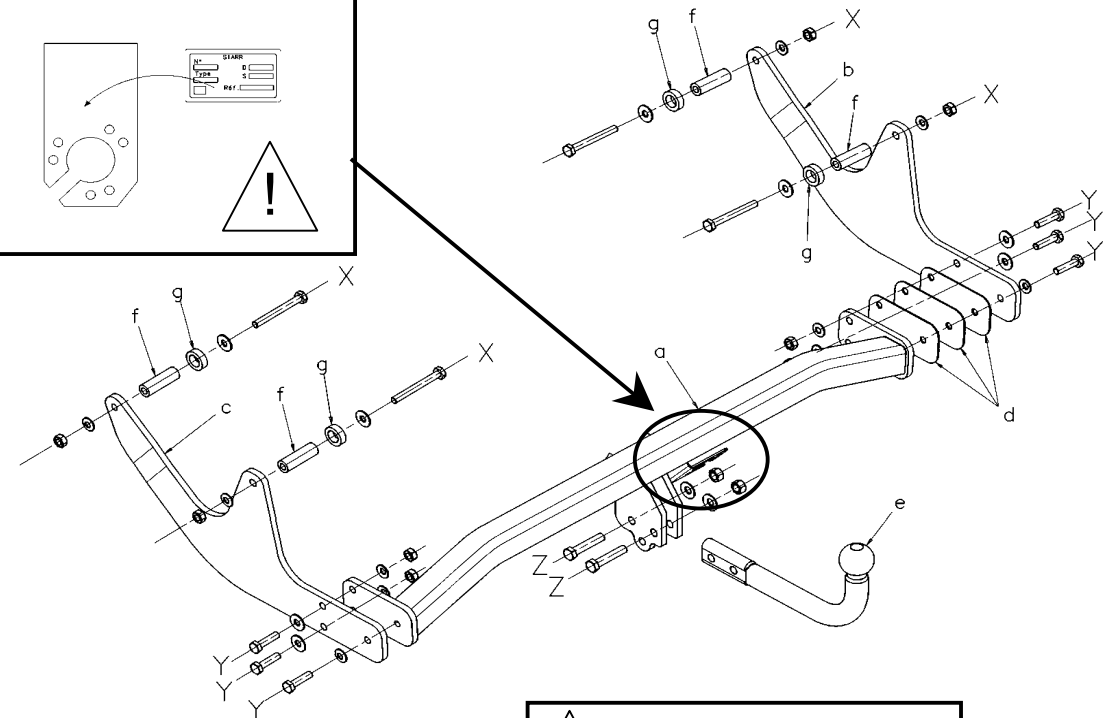
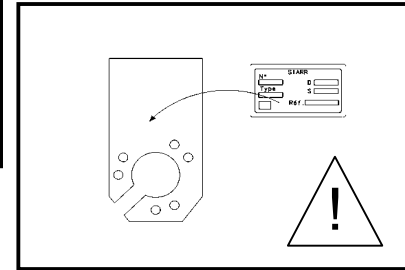

Fig. 2



! Lim etiketten på som

Type SI024	Homologering type nr.	Total vekt maks. godkjent	Total vekt mu- lig med tilhenger	Totalvekt tilhenger maks. avstand	Verdi D
Tilhengerfeste til Logan Break (RLD)	e24*94/20*00*0049	1 909 kg	1 300 kg	75 kg	7,59 kN

MERKNAD: Elektrisk skjema finnes i våre generelle eller personliggjorte brosjyrer.

DREININGSMOMENTER:

M16	AC8.8	19,5daNm	M12	AC10.9	11,4daNm	M8	AC8.8	2,3daNm
M16	AC10.9	27,5daNm	M10	AC8.8	4,7daNm	M8	AC10.9	3,3daNm
M12	AC8.8	8,1daNm	M10	AC10.9	6,7daNm			

ADVARSEL: (for kunnskap om bruksegenskapene, se vognkortet)

Ved å installere innretningen i samsvar med våre anbefalinger vil du få maksimalt utbytte av dette tilhengerfestet.

Vi fraskriver oss alt ansvar hvis tilhengerfestet endres eller brukes på ulovlig måte.

SIARR

04 - 146



INSTRUKCJA MONTAŻU



31625960001

PRZYGOTOWANIE

- * Wyjąć koło zapasowe.
- * Obniżyć tłumik wydechu.
- * Pod pojazdem, po wewnętrznej stronie podłużnicy ramy, odnaleźć i usunąć 4 uszczelki (2+2) odpowiadające punktom X.

MONTAŻ

- * Umocować prawe ramię „b” w punktach X za pomocą śrub C (rys.1).
- * Umocować lewe ramię « c » w punktach X za pomocą śrub X (rys. 2)
- * Zamocować poprzeczną belkę "a" do ramion "b" i "c" w punktach Y śrubami Y (jeśli jest luz, wstawić podkładki regulujące luz „d”).
- * Umocować przegub „e” w punktach Z za pomocą śrub Z

WYKOŃCZENIE

- * Dokręcić wszystkie śruby według momentów dokręcenia wskazanych poniżej.
- * Zamocować ponownie tłumik wydechu.
- * Umieścić z powrotem koło zapasowe.

ZESTAW ŚRUB

- X**
- 4 śruby HM10x90 (cl.10.9)
 - 3 podkładki regulujące luz (d)
 - 4 rozpórek o średnicy 10x20L.61 (f)
 - 4 płaskie podkładki okrągłe 10/27
 - 4 płaskie podkładki okrągłe CS10
 - 4 nakładki HM10 (cl10)
 - 4 okrągłe podkładki z pianki, grubość 10 (g)

- Y**
- 2 śruby HM12x60 (cl8.8)
 - 2 okrągłych podkładek CS12
 - 2 nakrętki HM12 (cl8)

- Z**
- 6 śrub HM12x40 5cl8.8)
 - 4 okrągłe podkładki płaskie 10x27
 - 6 płaskie podkładki okrągłe CS10
 - 4 nakrętki HM10 (cl8)

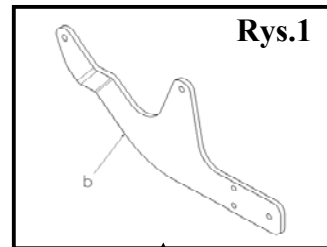

Rys.1

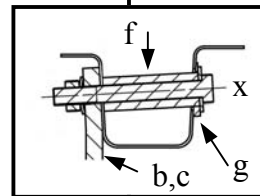

Rys.2

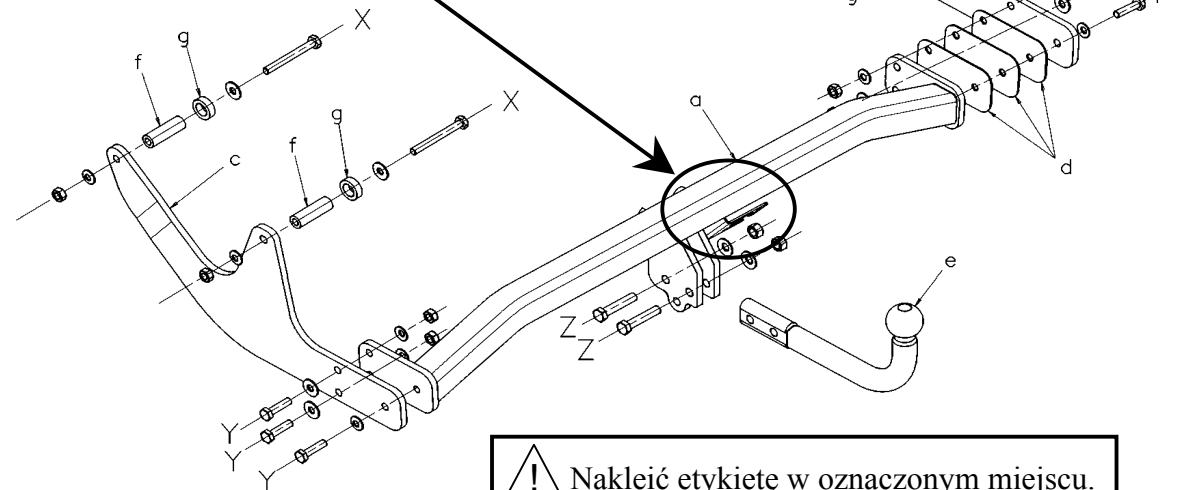
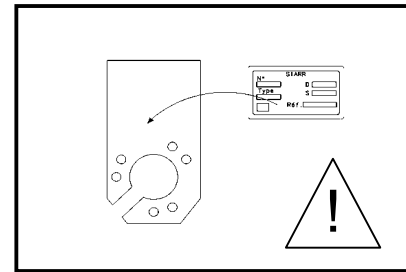

! Nakleić etykietę w oznaczonym miejscu.

Typ SI024	Homologacja typu nr	Ciężar całkowity <small>holowania / dopuszczalny</small>	Ciężar całkowity <small>holowania / dopuszczalny</small>	Maksymalne obciążenie pionowe	Wartość D
Dyszel holowniczy do Logan Break (RLD)	e24*94/20*00*0049	1 909 kg	1 300 kg	75 kg	7,59 kN

Uwaga: schemat elektryczny dołączony do wiązki podłączeniowej uniwersalnej lub specjalnej

MOMENTY DOKRĘCENIA

M16	AC8.8	19,5daNm	M12	AC10.9	11,4daNm	M8	AC8.8	2,3daNm
M16	AC10.9	27,5daNm	M10	AC8.8	4,7daNm	M8	AC10.9	3,3daNm
M12	AC8.8	8,1daNm	M10	AC10.9	6,7daNm			

UWAGA (charakterystyki użytkowania należy sprawdzić w dowodzie rejestracyjnym)

Dyszel holowniczy będzie funkcjonował we właściwy sposób po zainstalowaniu go zgodnie z zaleceniami. Nie ponosimy żadnej odpowiedzialności w przypadku wprowadzenia zmian lub niedozwolonego użycia



FÖRBEREDELSE

- * Ta bort reservhjulet.
- * Ta ned avgasröret.
- * Ta bort de fyra ventilerna (2+2) som finns inuti långbalkarna som sitter under fordonet (punkterna X).

MONTERING

- * Placera höger arm « b » i de markerade punkterna X med hjälp av skruvblock X (Enligt skiss1).
- * Placera vänster arm « c » i de markerade punkterna X med skruvblock X (Bild 2).
- * Placera tvärbalk "a" med armar "b" och "c" i punkterna Y med hjälp av skruvblock Y (om det finns valsspalt, skjut in styrlisterna « d »).
- * Placera kullad « e » i punkterna Z med hjälp av skruvblock Z.

SLUTLIGEN

- * Utför vridmomentet enligt anvisningarna här nedan.
- * Sätt tillbaka avgasröret.
- * Lägg tillbaka reservhjulet.

SKRUVBLOCK

- X**
- 4 skruvar HM10x90 (c1.10.9)
 - 3 styrlister (d)
 - 4 distanshylsor, diam.10x20L.61 (f)
 - 4 rundbrickor 10/27
 - 4 fjäderbrickor CS10
 - 4 muttrar HM10 (c110)
 - 4 mjuka brickor tj.10 (g)

- Y**
- 2 skruvar HM12x60 (c18.8)
 - 2 fjäderbrickor CS12
 - 2 muttrar HM12 (c18)

- Z**
- 6 skruvar HM10x40 (c18.8)
 - 4 rundbrickor 10x27
 - 6 fjäderbrickor CS10
 - 4 muttrar HM10 (c18)

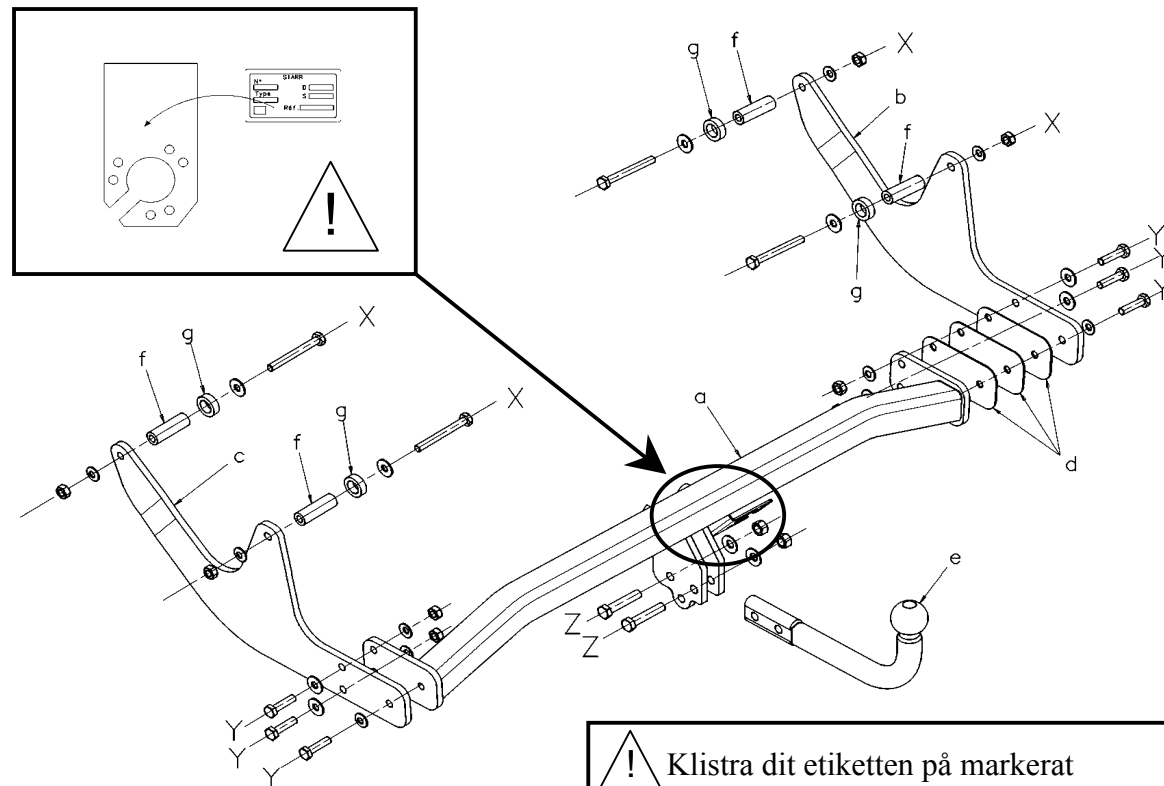
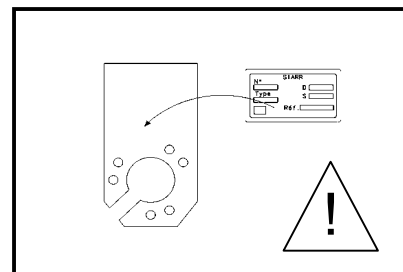
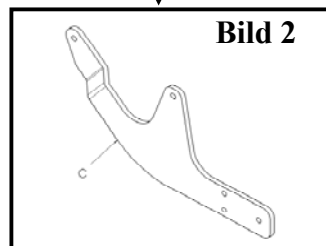
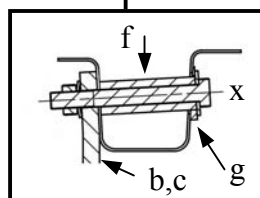
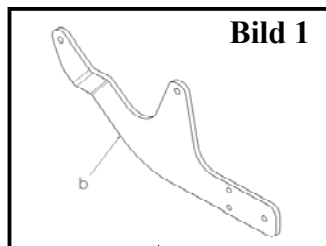

! Klustra dit etiketten på markerat

Typexemplar SI024	Typgodkännande Av typexemplar n°	Totalvikt Maxi-vikt	Totalvikt bogserbar	Vertikal maxi-vikt	Värde D
Montering av Logan Break (RLD)	e24*94/20*00*0049	1 909 kg	1 300 kg	75 kg	7,59 kN

Observera: Elektriskt schema finns i våra allmänna eller mer specialiserade anvisningar

VRIDMOMENT:

M16	AC8.8	19,5daNm	M12	AC10.9	11,4daNm	M8	AC8.8	2,3daNm
M16	AC10.9	27,5daNm	M10	AC8.8	4,7daNm	M8	AC10.9	3,3daNm
M12	AC8.8	8,1daNm	M10	AC10.9	6,7daNm			

WARNING: (Läs igenom det grå bladet för att ta reda på rådande användningsvillkor)

Om du monterar produkten enligt våra anvisningar kommer du uppnå bästa möjliga resultat
Vi avsäger oss allt ansvar i de fall kunden inte följt våra anvisningar fullt ut.